

KELDERVLOER

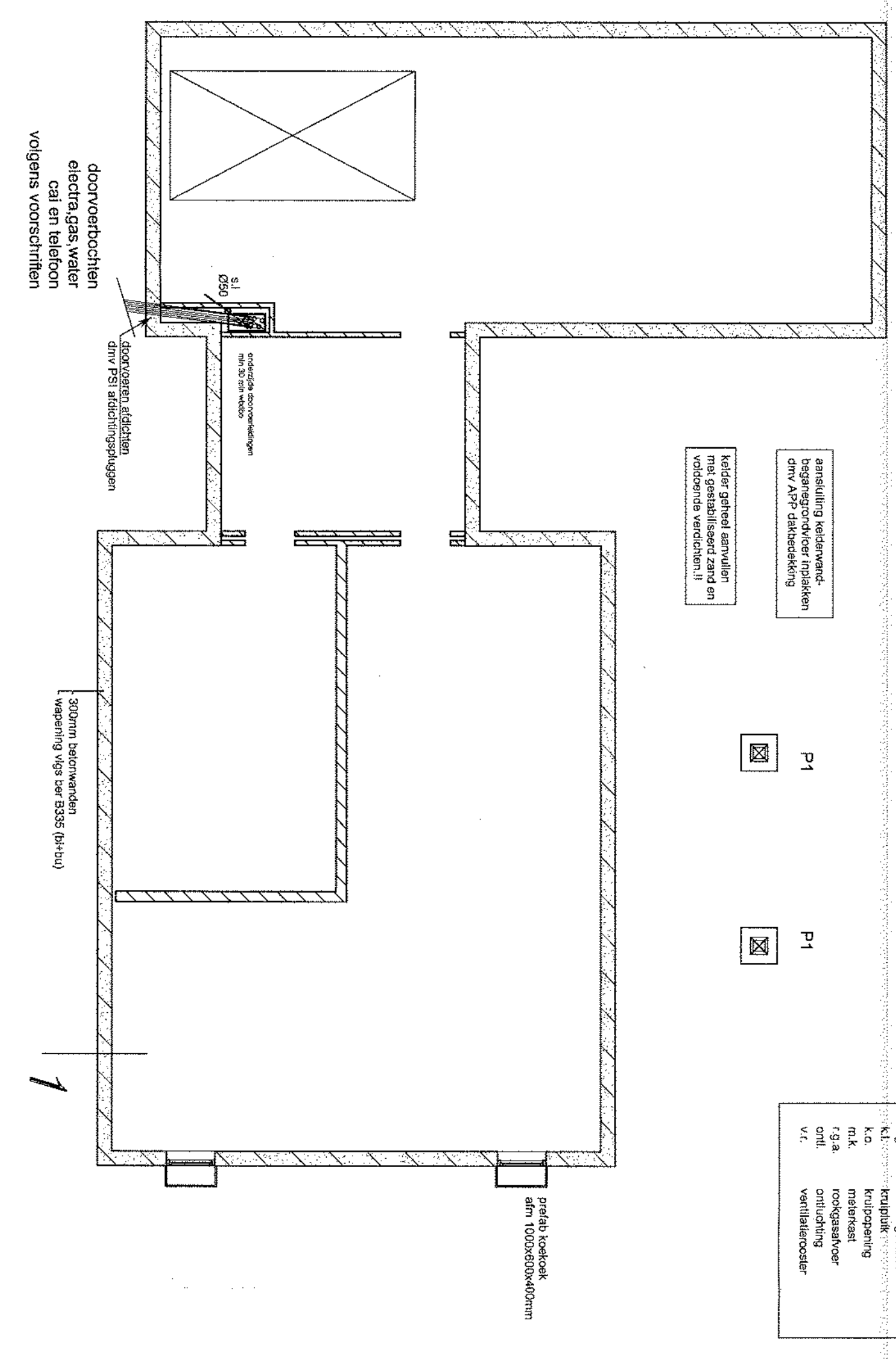

KELDERWAND/FUNDERING

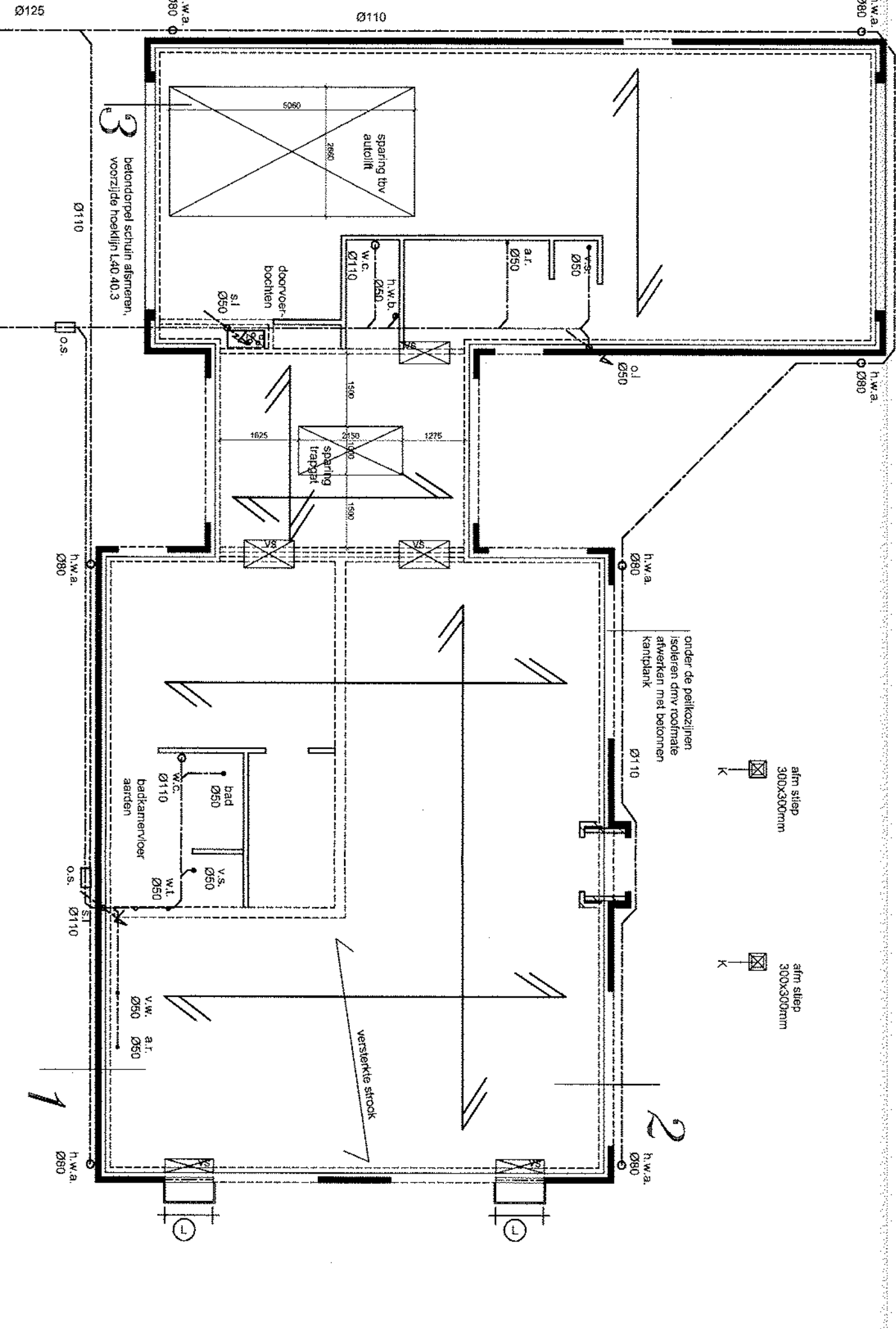

KELDERDEKKRIOLERING

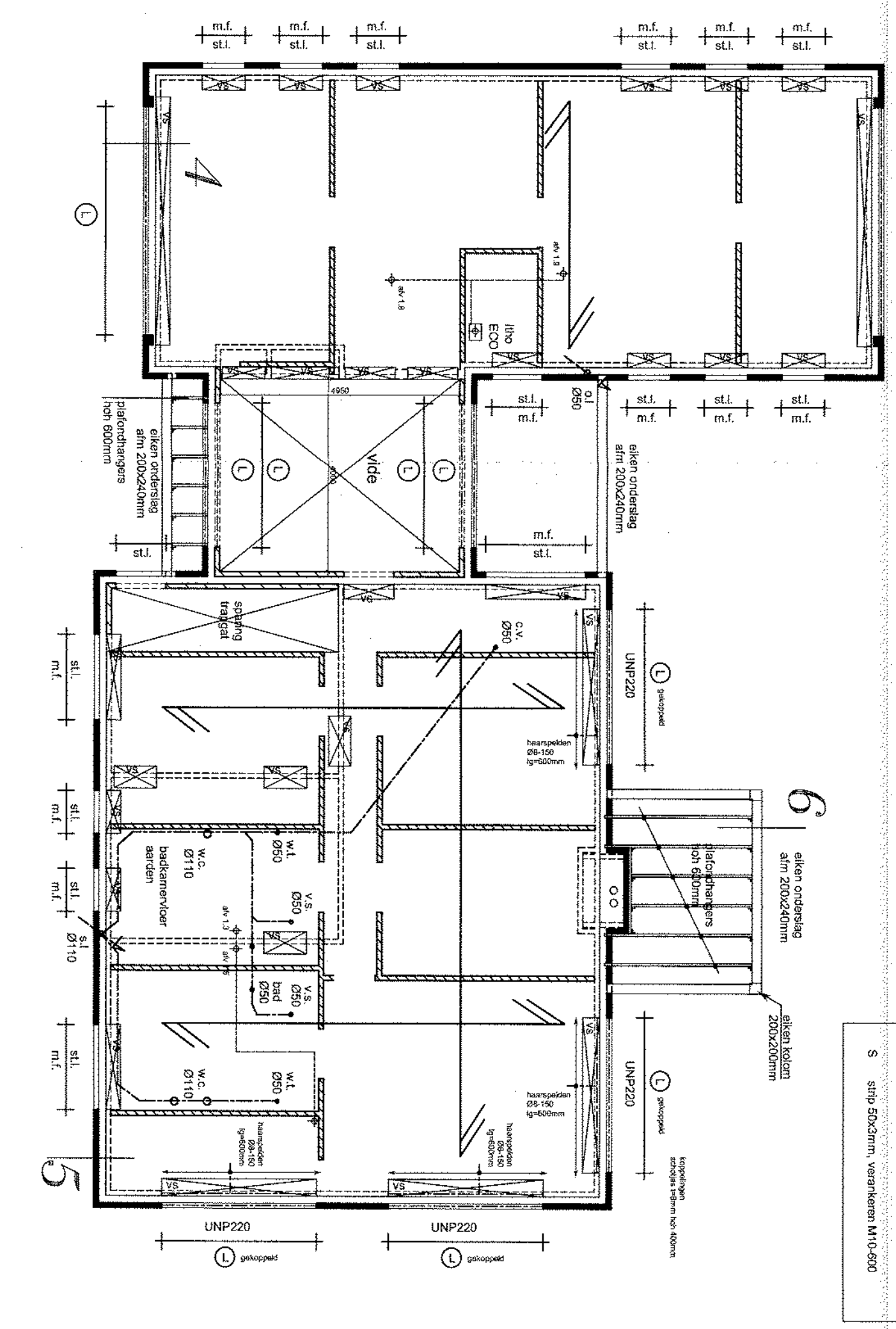

VERDIEPINGSVLOER

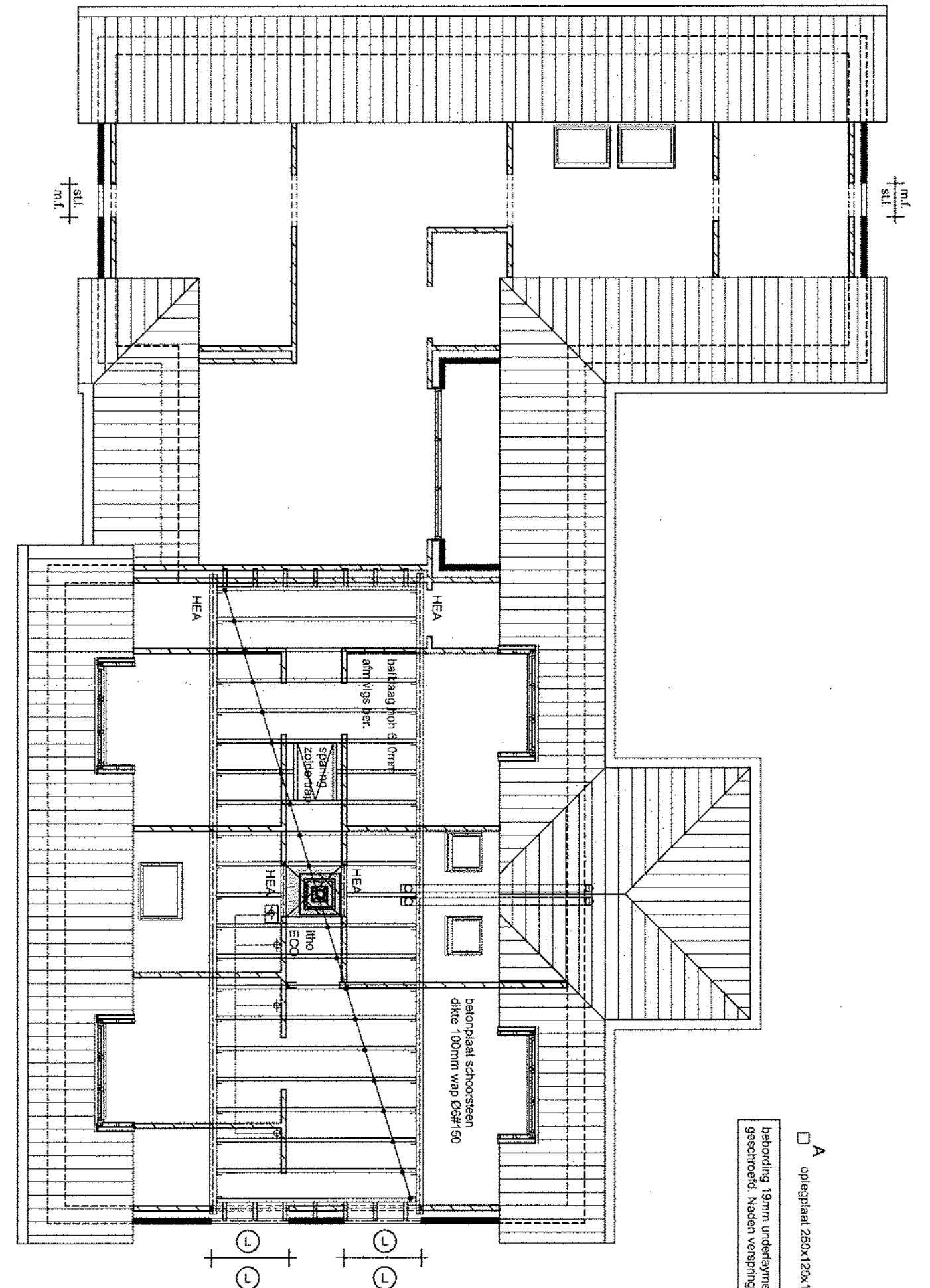

ZOLDERVLOER

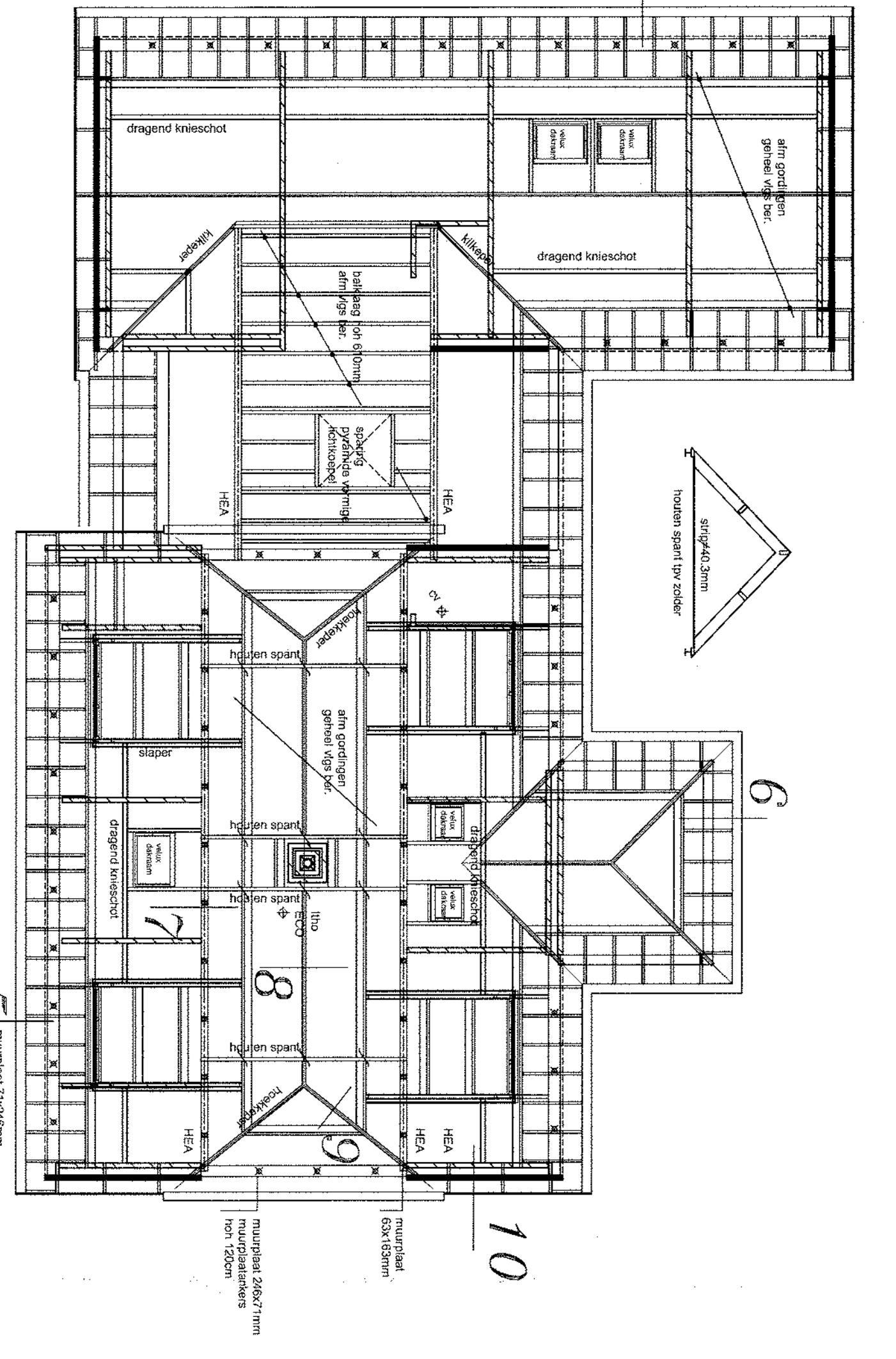

KAPPLAN

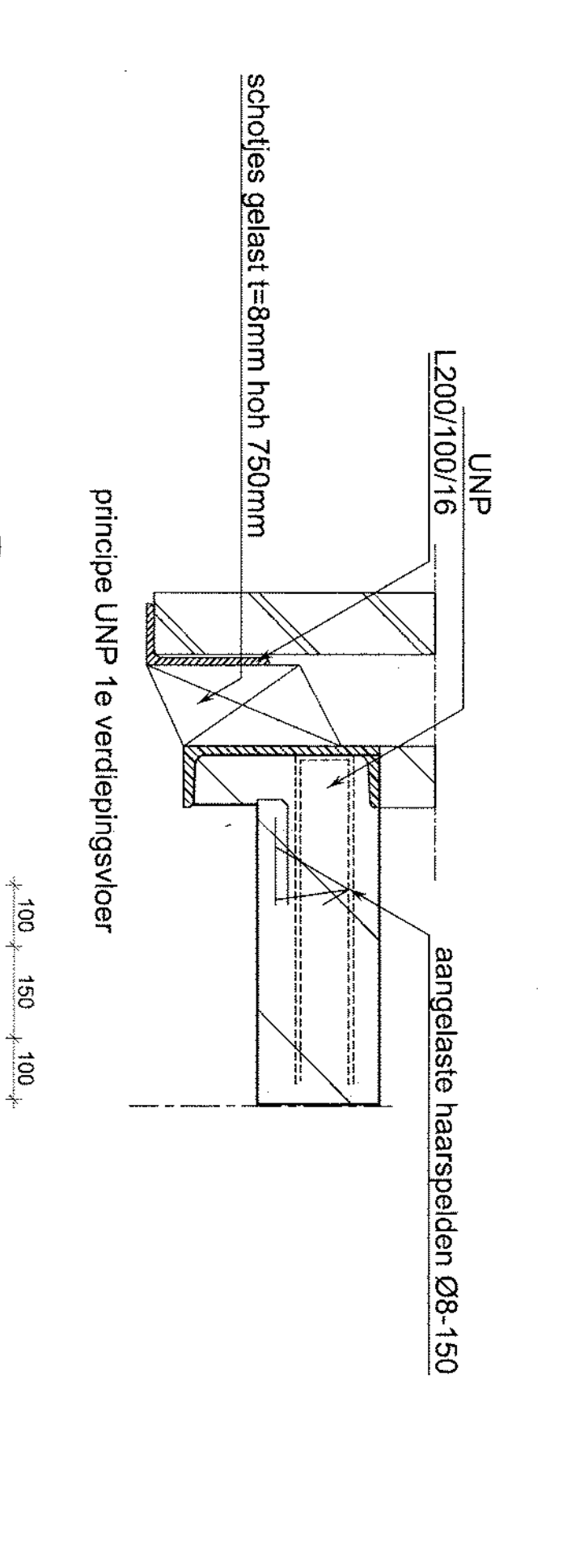

1

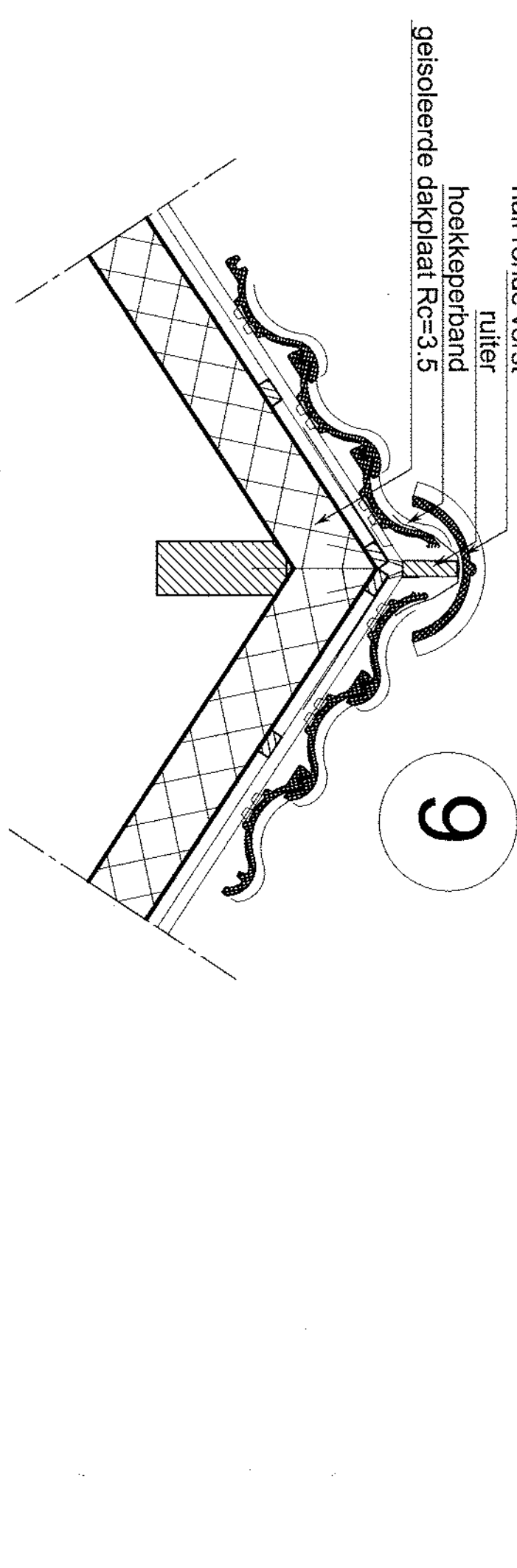

9

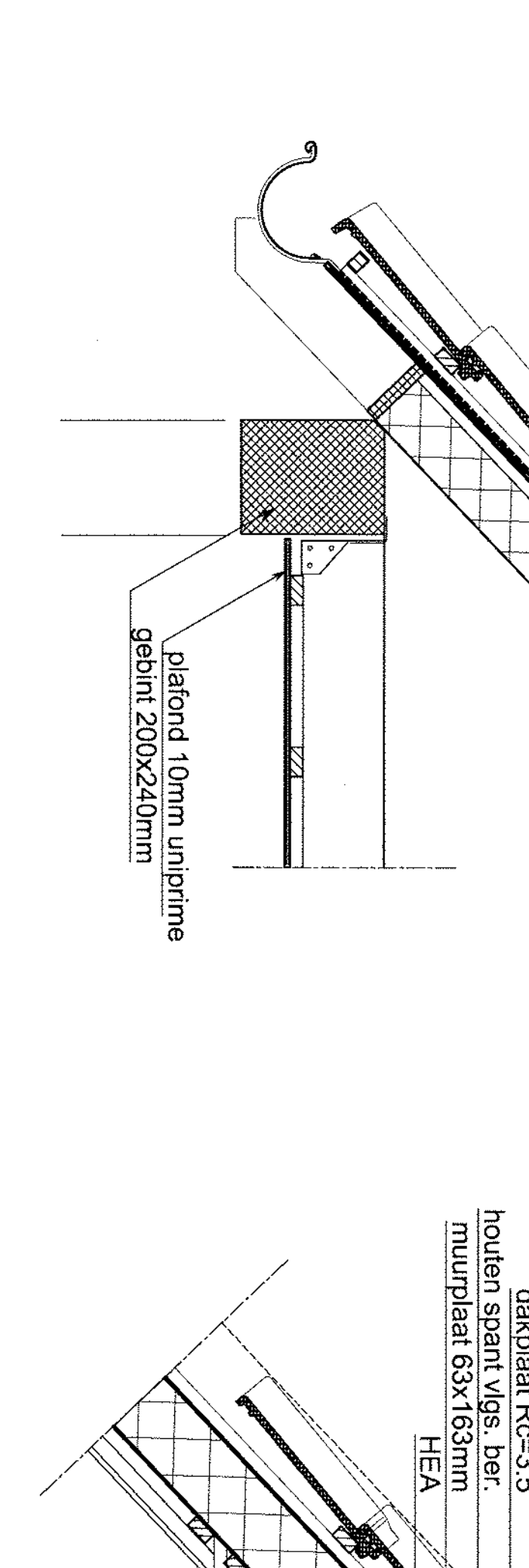

6

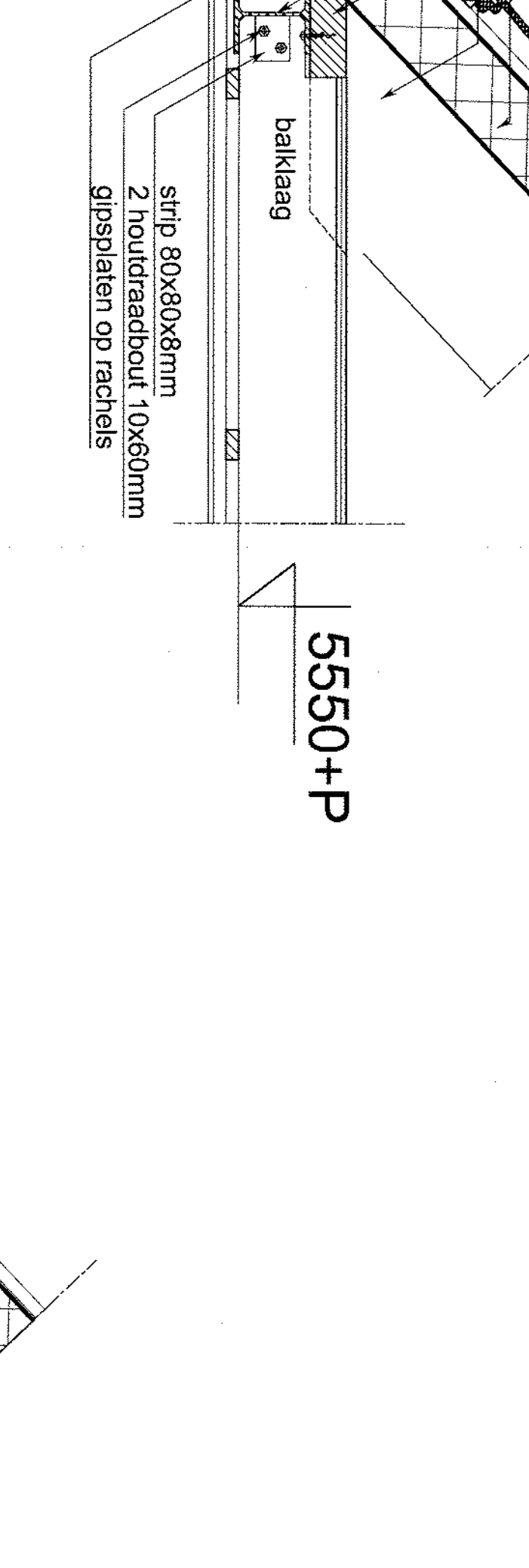

8

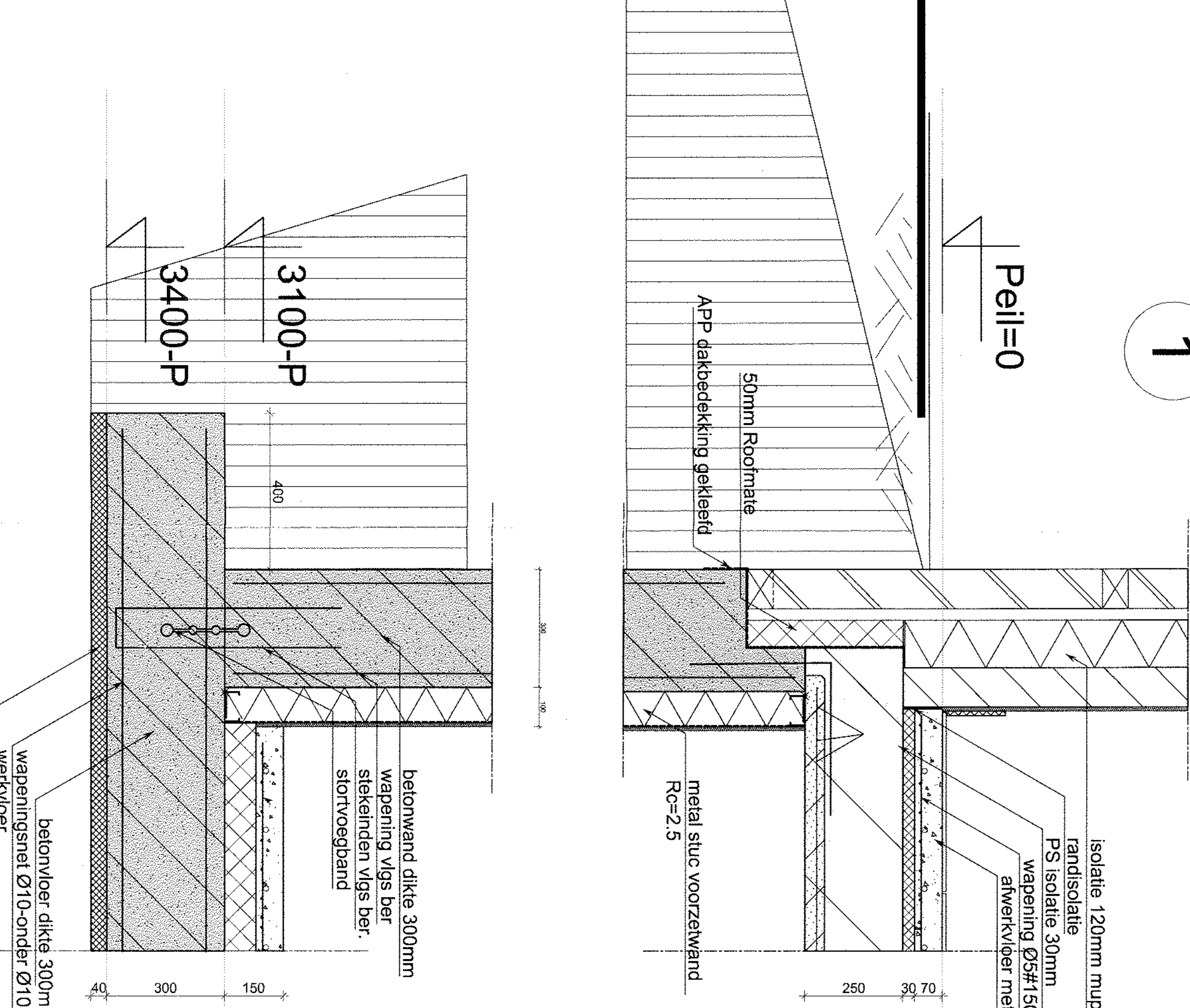

1

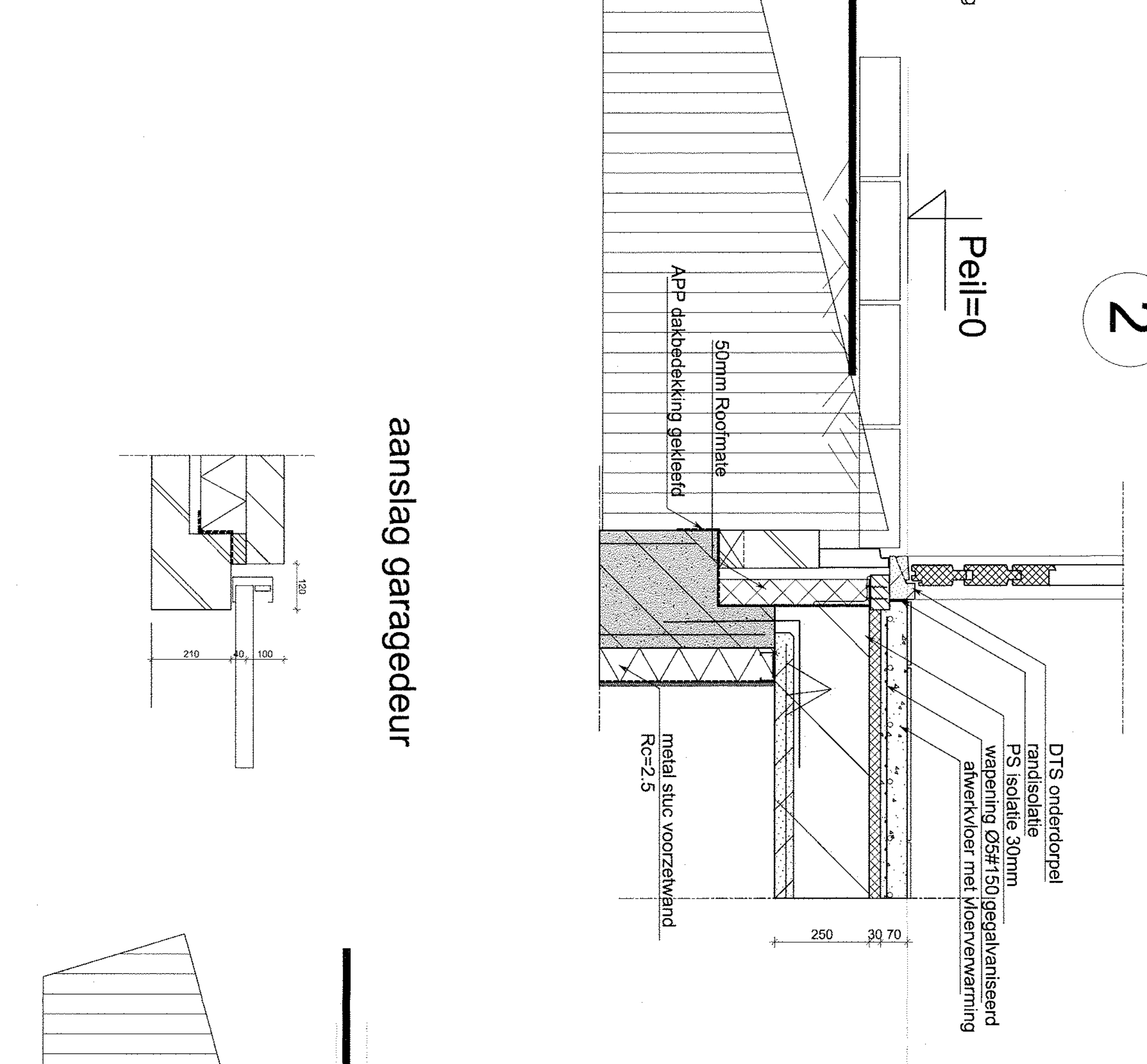

2

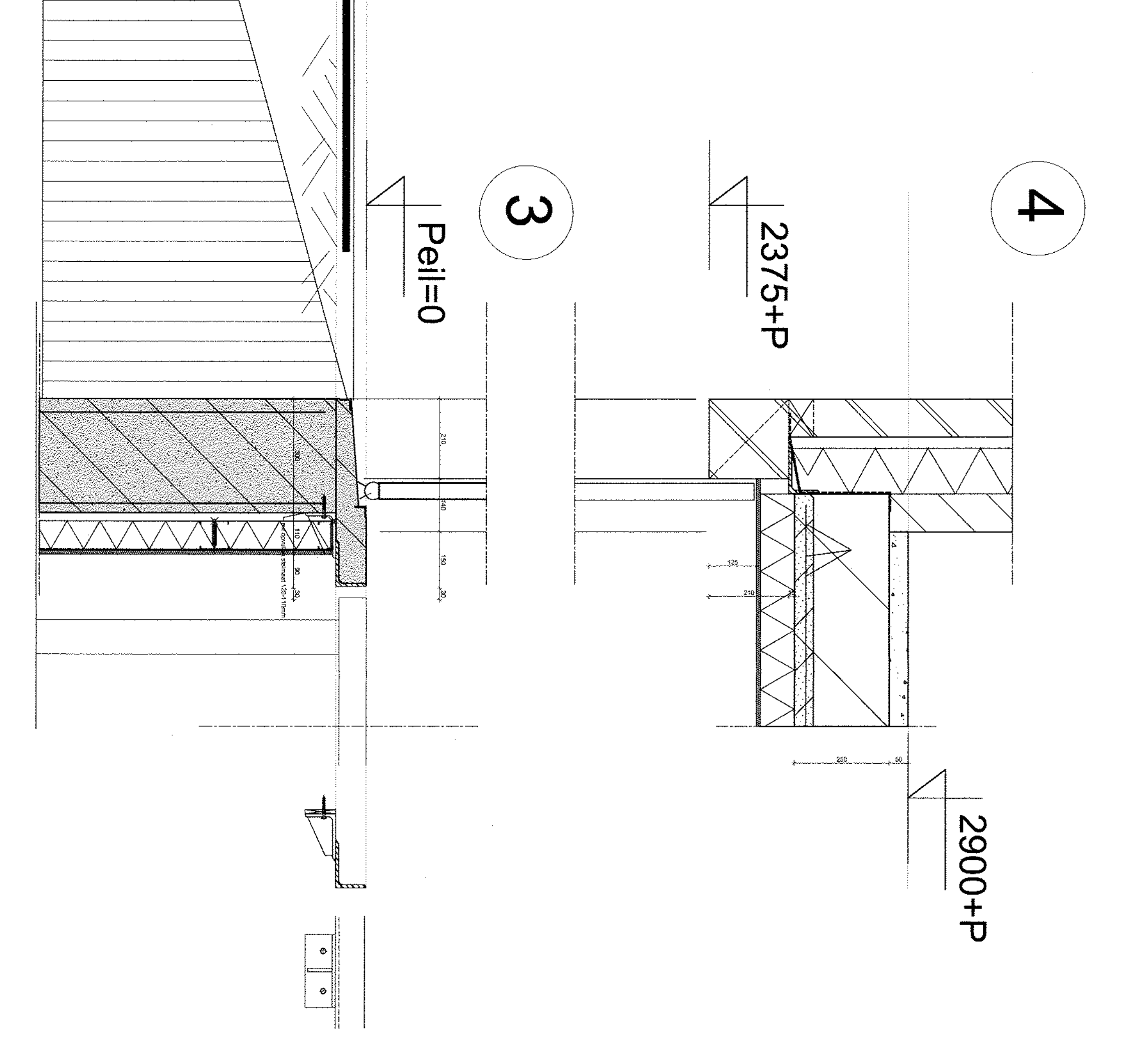

4

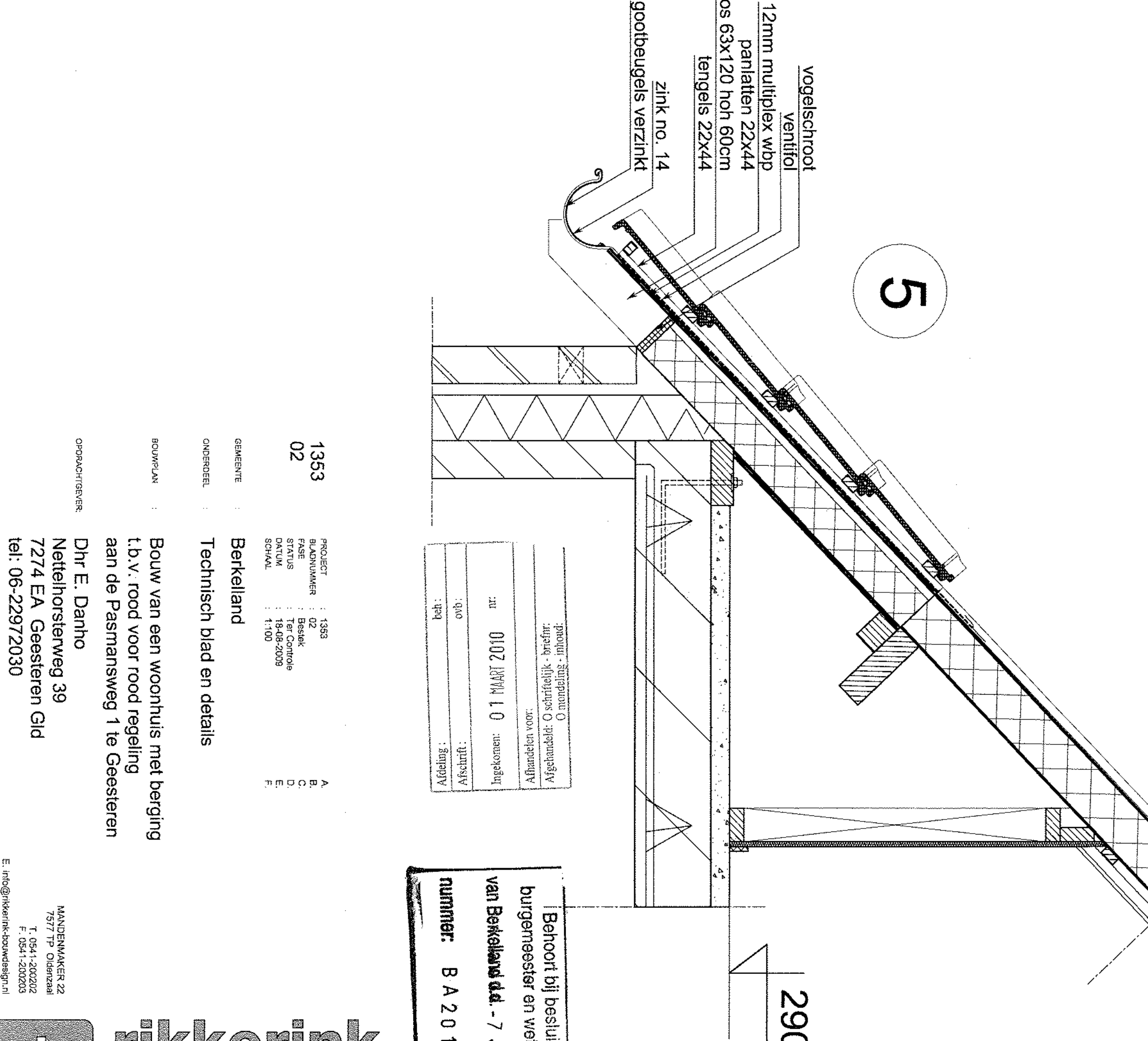

5

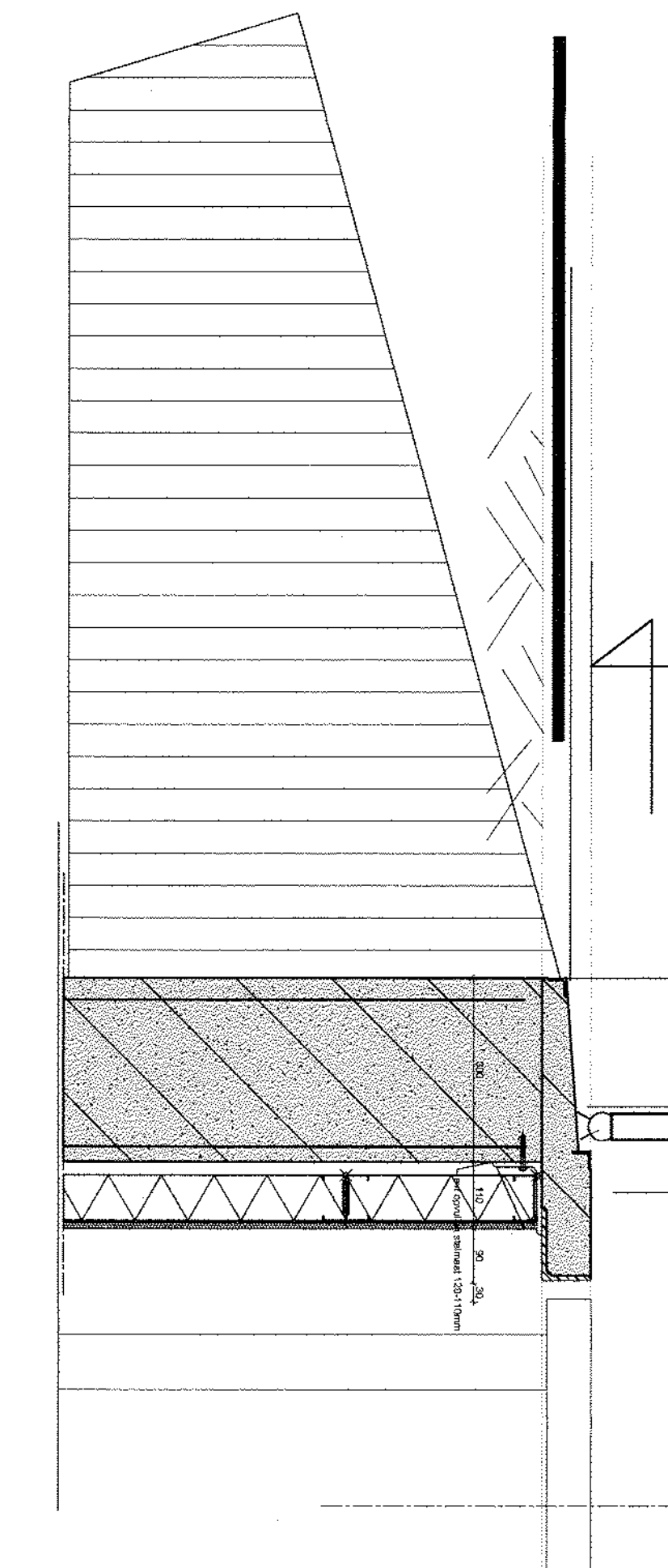

3

1353
02

PROJECT: 1353
NAAM: 02
ADRES: 7274 EA Geesteren Cd
TELEFON: 06-22972030
E-MAIL: info@rikkerink.nl
WWW: www.rikkerink.nl

OPDRACHTGEVER: Berckeland
TECHNISCH BIJBLAD EN DETAILS

BOUW VAN EEN WOONHUIS MET BERGING
I.B.V. ROOD VOOR REGELING
AAN DE PASTORISWEG 1 TE GEESTEREN

DIRK E. DANHO
NIEUWROSTERWEG 39
7274 EA GEESTEREN CD
TEL: 06-22972030

Baanrood bij besluit van
burgemeester en wethouders
van Beekland d.d. 7 JUN 2010
nummer: BA 2 0 1 0 0 4 8

rikkerink
bouwdesign